

CE

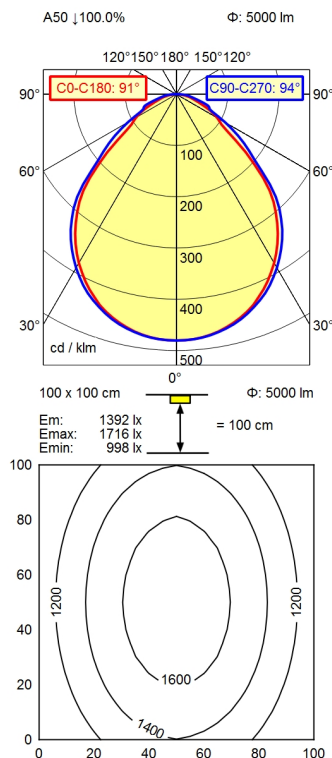

GST 18i3F REV



Light source	LED
Work equipment	Power supply unit
Connected load	220 - 240 V; AC; 50 Hz; 60 Hz
Power consumption	ca. 63 W
Luminous flux	approx. 5.000 lm
Luminous efficiency	approx. 79 lm/W
Light type/-color	Cold white
Colour temperatur	approx. 5.000 K
Color rendering index	CRI ≥ 80
Light distribution	Direct
Direct ratio	approx. 100 %
Beam angle	92°
Glare control	Structured screen
Luminance (L65)	≤ 13.000 cd/m ²
Unified glare rating (4H 8H)	≤ 25
System of protection	IP 20
Class of protection	I
Technology	Switchable; -
Operation	Rocker switch
Housing	Aluminium/plastic; Anodised; Aluminium coloured anodised Structured
Light source cover	
Weight (net)	ca. 1,6 kg
Mains lead	Built-in plug; GST 18i3F REV
Design	mounted version
Fastening	Lamp bracket (accessory)
Dimension	A=1499 mm
Decorative contrast side parts	Dusty grey
Special features	Through-wired