

series 272

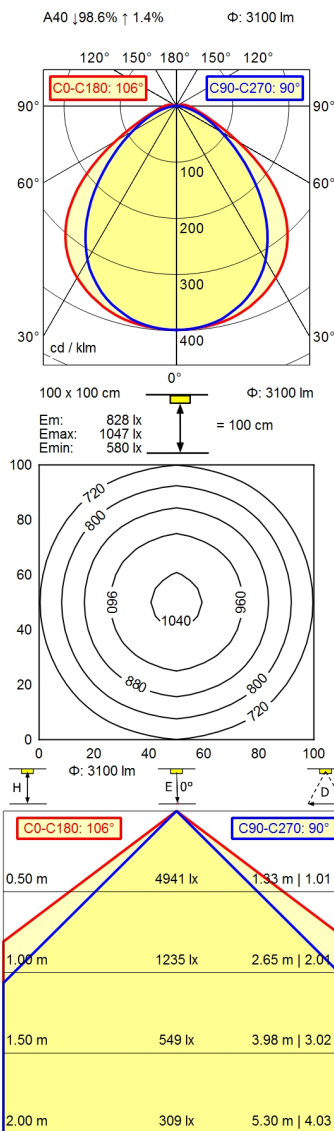

Light source	LED
Work equipment	Without
Connected load	230 V; AC; 50 Hz; 60 Hz
Power consumption	ca. 40 W
Luminous flux	approx. 3.100 lm
Luminous efficiency	approx. 77 lm/W
Light type/-color	Cold white
Colour temperatur	approx. 5.000 K
Color rendering index	CRI ≥ 80
Light distribution	Direct
Direct ratio	approx. 99 %
Beam angle	100°
Chromaticity tolerance LED	< 4 SDCM
Glare control	Diffuser foil
Luminance (L65)	≤ 17.000 cd/m ²
Unified glare rating (4H 8H)	≤ 25
System of protection	IP 67
Class of protection	I
Technology	Switchable; -
Operation	External
Housing	Acrylic (PMMA), clear
Light source cover	Acrylic (PMMA)
Weight (net)	ca. 2,1 kg
Mains lead	Connector; series 272
Fastening	Pipe clamp (accessory)
Dimension	A=790 mm
Light output	D=736 mm
Side part	A with screwed cable gland
Maximum ambient temperature	40 °C
Special features	Light forming