

Serie 814

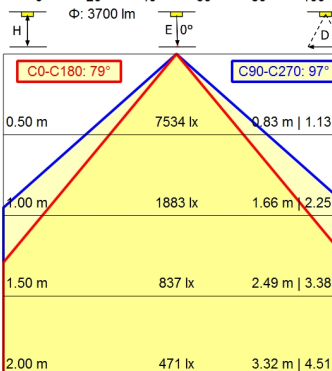
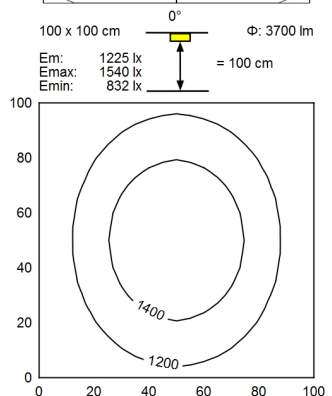
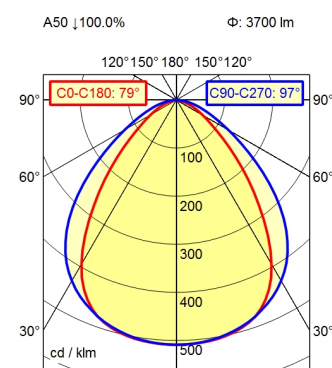

Light source	LED
Work equipment	Electronic ballast
Connected load	220 - 240 V; AC; 50 Hz; 60 Hz
Power consumption	ca. 43 W
Luminous flux	approx. 3.700 lm
Luminous efficiency	approx. 86 lm/W
Light type/-color	Cold white
Colour temperatur	approx. 5.000 K
Color rendering index	CRI ≥ 80
Light distribution	Direct; Symmetric
Beam angle	80°/100°
Chromaticity tolerance LED	< 4 SDCM
Luminance (L65)	≤ 27.000 cd/m ²
Unified glare rating (4H 8H)	≤ 25
System of protection	IP 67
Class of protection	I
Technology	Switchable; -
Operation	External
Housing	Aluminium; Anodised; Aluminium coloured anodised Borosilicate; Clear
Light source cover	
Weight (net)	ca. 3,8 kg
Mains lead	Built-in plug; Serie 814
Design	mounted version
Fastening	L-angle; Clamp
Dimension	A=1070 mm
Minimum ambient temperature	-10 °C
Maximum ambient temperature	40 °C
Special features	Power equipment