

Mito soffitto 40 flat datasheet

Annular LED ceiling-mounted luminaire with single-sided light output and a diameter of 40 cm. There is a choice of two lighting effects. As room lighting, ceiling (narrow) provides a concentrated, dazzle-free light beam for perfect lighting in all situations. wall to wall (wide) for installation on walls especially in halls or corridors in order to brighten up the opposite areas with targeted lighting without dazzling – wide light beam.

Version for hollow ceiling including power supply unit and cover for fitting and inspecting the power supply unit. Dimmable via trailing-edge phase-cut dimmer*; can alternatively be controlled via Occhio air or DALI. Connection to 230V AC mains voltage. The color temperature can be preset (2700/3000/3500/4000 K) or can be continuously controlled from 2700 to 4000 K via Occhio air or DALI.

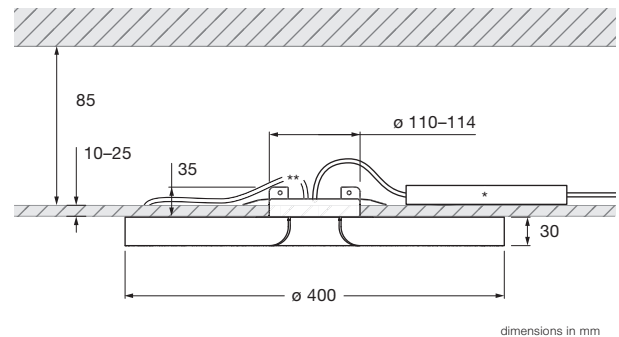

** incl. power supply unit (removable), dimensions: L 170 x W 89 x H 27
** luminaire cable: 1 m

technical data Mito soffitto 40 flat

properties	material	aluminium, painted, PVD-coated steel, plastic, optical silicone
	weight	1.3 kg
surface	head	bronze, matt gold, rose gold, matt silver, matt white, matt black, phantom, black phantom
	cover	matt white, matt black
Occhio »color tune« LED	average life time	> 50.000 hrs
	energy efficiency class (luminous efficiency)	G (43 lm / W)
	power	LED 40 W (incl. Occhio power supply unit approx. 46 W, standby < 0.5 W)
	color rendering index	high color; CRI Ra 95
electricity	color temperature (color consistency)	2700–4000 K (2-step)
	dimming	via trailing-edge phasecut dimmer, Occhio air (optional) or DALI *
	connection	230V AC
	power factor power supply (cos φ1)	0.9
	flicker / stroboscopic effect	1 (PstLM) / 0.9 (SVM)
permitted operating conditions	max. 30°C for indoor use only	

* For a list of compatible dimmers, see www.occhio.de/dim_en, trailing-edge phasecut dimmer, Occhio air and DALI not combinable

Mito soffitto 40 flat lighting effects

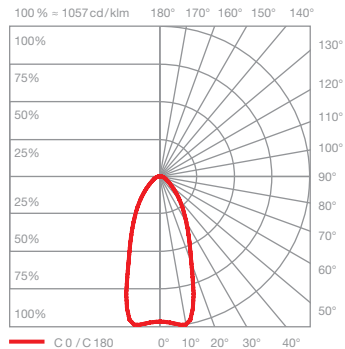

ceiling (narrow)

concentrated light, beam angle approx. 50°

inserts: narrow

luminous flux : high color 40 W 1440 lm

UGR (4H8H) > 19*

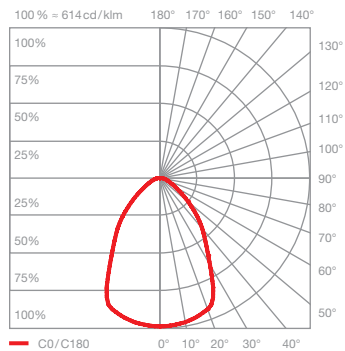
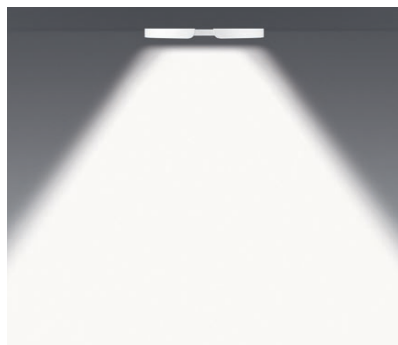

ceiling (wide)

wide-radiation light, beam angle approx. 80°

inserts : wide

luminous flux : high color 40 W 1700 lm

UGR (4H8H) > 19*

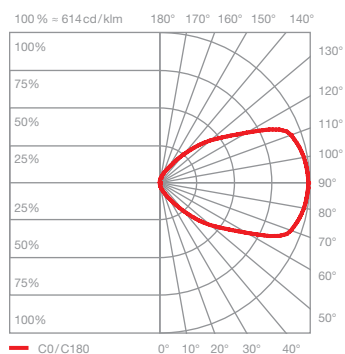
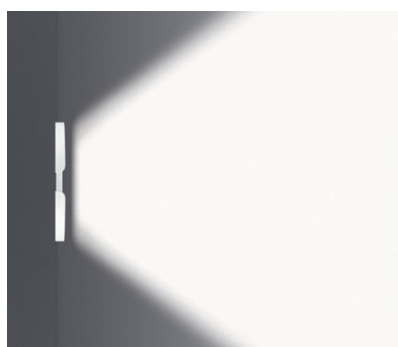

wall to wall (wide)

wide-radiation light, beam angle approx. 80°

inserts : wide

luminous flux : high color 40 W 1700 lm

*The standardized indication of glare values (UGR value - 4H8H) is not quite significant for annular luminaires. In most real applications the result of an individual calculation is a UGR value <19. Therefore, we recommend to carry out a calculation which can be prepared by our lighting design team (project-support@occhio.de).

control options

Control

Mito set box



sospeso / aura /
sfera / sfera su / volo



soffitto / alto flat



alto & alto side

sospeso / aura / sfera / volo:

COLOR (Sensor off)
adjustable color temperature (4 steps)
trailing-edge phase cut dimming possible

PRESET (sospeso / aura / volo)
adjustable color temperature (4 steps)
adjustable up / downlight ratio (5 steps)
trailing-edge phase cut dimming possible

PRESET (sfera)
color temperature adjustable (4 stages)
light intensity adjustable (5 stages)

SENSOR

»touchless control« (gesture control)
switching, dimming, up / down fading*
»color tune« (color temperature continuously adjustable)
no external dimming possible

*not with sfera

soffitto / alto / alto side:

COLOR
adjustable color temperature (4 steps)
trailing-edge phase cut dimming possible

Mito »air« box

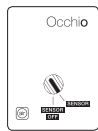

sospeso / aura /
sfera / volo

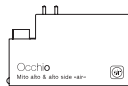

alto & alto side



Occhio air (Bluetooth control using Occhio air app) or air controller (optional) control of individual luminaires, groups and scenes

sospeso / aura / sfera / volo:

SENSOR
»air« + »touchless control« (Bluetooth- and gesture control)
control via »touchless control« and Occhio air app or »air« controller

SENSOR OFF

»air«
control via Occhio air App or »air« controller
switching, dimming, up / down fading »color tune« (color temperature continuously adjustable)



terra / raggio / largo /
soffitto / alto flat

terra / largo / raggio:

»air«, »touchless control« and »body sensor« (raggio / terra) (Bluetooth- and gesture control)
control via »touchless control«, »body sensor« and Occhio air App or »air« controller

alto / alto side:

»air« (Bluetooth - control)
control via Occhio air App or »air« controller
switching, dimming
»color tune« (color temperature continuously adjustable)

»ambient light control« (terra)
adjustment to ambient light

»presence sensor« (terra)
presence identification and automatically shutdown by presence sensor

deactivation and adjustable via control and sensor with »air« app

with Mito »air« box no external dimming possible

Mito DALI box (control via DALI)



sospeso / volo /
soffitto / alto flat



aura



alto & alto side up

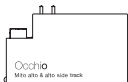

alto & alto side track

sospeso / aura / volo:

- color tune adjustable*
- adjust continuously dimming
- up + downlight separate controllable (two DALI addresses needed)
- no »touchless control«, no fading

soffitto / alto / alto side:

- color tune adjustable*
- continuously dimming

* DALI controller DALI Device type 8 (DT8) for controlling of the color tune necessary further signs on www.occhio.com/dali

Mito soffitto 40 flat DALI connection diagram

A maximum of 64 Mito soffitto units can be assigned to each DALI circuit.

The Mito soffitto units can be organized into as many as 16 groups and equipped with an additional 16 scenarios (predefined settings).

Using a DALI short address, they can be actuated and configured individually. In addition, the bi-directional data transfer lets users query the state/status of individual luminaires.

You can find more detailed information at www.occhio.com/dali.

